

**HIGHLIGHTS OF PRESCRIBING INFORMATION**

These highlights do not include all the information needed to use NOVOLOG MIX 50/50 safely and effectively. See full prescribing information for NOVOLOG MIX 50/50.

**NOVOLOG<sup>®</sup> MIX 50/50 (insulin aspart protamine and insulin aspart injectable suspension), for subcutaneous use**  
**Initial U.S. Approval: 2008**

-----**RECENT MAJOR CHANGES**-----  
Dosage and Administration (2.1).....02/2019

-----**INDICATIONS AND USAGE**-----

NOVOLOG MIX 50/50 is a mixture of insulin aspart protamine, an intermediate-acting human insulin analog, and insulin aspart, a rapid-acting human insulin analog indicated to improve glycemic control in patients with diabetes mellitus.

Limitations of Use:

- Not recommended for the treatment of diabetic ketoacidosis.
- The proportions of rapid-acting and intermediate-acting insulins are fixed and do not allow for basal versus prandial dose adjustments (1).

-----**DOSAGE AND ADMINISTRATION**-----

- Inject NOVOLOG MIX 50/50 subcutaneously in the abdominal region, buttocks, thigh, or upper arm (2.1).
- Administer the dose within 15 minutes before meal initiation. For patients with type 2 diabetes, the dose may also be given after meal initiation (2.1).
- Rotate injection sites within the same region from one injection to the next (2.1).
- Inspect visually before use. Appearance should be uniformly white and cloudy. Do not use it if it looks clear or if it contains solid particles (2.1).
- NOVOLOG MIX 50/50 must be resuspended immediately before use. Resuspension is easier when the insulin has reached room temperature (2.1).
- Do not administer intravenously or use in insulin infusion pumps (2.1).
- NOVOLOG MIX 50/50 may be administered up to three times daily (2.2). Individualize dosage based on metabolic needs, blood glucose monitoring results, glycemic control goal (2.2).
- Dosage adjustments may be needed with changes in physical activity, changes in meal patterns (i.e., macronutrient content or timing of food intake), changes in renal or hepatic function or during acute illness (2.2).
- Dosage adjustment may be needed when switching from another insulin to NOVOLOG MIX 50/50 (2.2).

-----**DOSAGE FORMS AND STRENGTHS**-----

Injectable suspension: NOVOLOG MIX 50/50 is 100 units per mL (U-100), 50% insulin aspart protamine and 50% insulin aspart, is available as: (3)

- 3 mL single-patient-use PenFill<sup>®</sup> cartridges
- 3 mL single-patient-use NOVOLOG MIX 50/50 FlexPen<sup>®</sup>

-----**CONTRAINDICATIONS**-----

- Do not use during episodes of hypoglycemia (4).
- Do not use in patients with hypersensitivity to NOVOLOG MIX 50/50 or one of its excipients (4).

-----**WARNINGS AND PRECAUTIONS**-----

- Never share NOVOLOG MIX 50/50 FlexPen between patients, even if the needle is changed (5.1).
- *Hyper- or hypoglycemia with changes in insulin regimen:* Carry out under close medical supervision and increase frequency of blood glucose monitoring (5.2).
- *Hypoglycemia:* May be life-threatening. Increase frequency of glucose monitoring with changes to: insulin dosage, co-administered glucose lowering medications, meal pattern, physical activity; and in patients with renal or hepatic impairments and hypoglycemia unawareness (5.3).
- *Medication Errors:* Accidental mix-ups between insulin products can occur. Instruct patients to check insulin labels before injection (5.4).
- *Hypersensitivity reactions:* Severe, life-threatening, generalized allergy, including anaphylaxis, may occur. Discontinue NOVOLOG MIX 50/50, treat, and monitor, if indicated (5.5).
- *Hypokalemia:* May be life-threatening. Monitor potassium levels in patients at risk of hypokalemia and treat if indicated (5.6).
- *Fluid retention and heart failure with concomitant use of thiazolidinediones (TZDs):* Observe for signs and symptoms of heart failure; consider dosage reduction or discontinuation if heart failure occurs (5.7).

-----**ADVERSE REACTIONS**-----

Adverse reactions observed with insulin therapy include hypoglycemia, allergic reactions, local injection site reactions, lipodystrophy, rash and pruritus (6).

**To report SUSPECTED ADVERSE REACTIONS, contact Novo Nordisk Inc. at 1-800-727-6500 or FDA at 1-800-FDA-1088 or [www.fda.gov/medwatch](http://www.fda.gov/medwatch).**

-----**DRUG INTERACTIONS**-----

- *Drugs that may increase the risk of hypoglycemia:* antidiabetic agents, ACE inhibitors, angiotensin II receptor blocking agents, disopyramide, fibrates, fluoxetine, monoamine oxidase inhibitors, pentoxifylline, pramlintide, propoxyphene, salicylates, somatostatin analog (e.g., octreotide), and sulfonamide antibiotics (7).
- *Drugs that may decrease the blood glucose lowering effect:* atypical antipsychotics, corticosteroids, danazol, diuretics, estrogens, glucagon, isoniazid, niacin, oral contraceptives, phenothiazines, progestogens (e.g., in oral contraceptives), protease inhibitors, somatropin, sympathomimetic agents (e.g., albuterol, epinephrine, terbutaline), and thyroid hormones (7).
- *Drugs that may increase or decrease the blood glucose lowering effect:* alcohol, beta-blockers, clonidine, lithium salts, and pentamidine (7).
- *Drugs that may blunt the signs and symptoms of hypoglycemia:* beta-blockers, clonidine, guanethidine, and reserpine (7).

**See 17 for PATIENT COUNSELING INFORMATION and FDA-approved patient labeling.**

**Revised: [02/2019]**

**FULL PRESCRIBING INFORMATION: CONTENTS\***

- 1 INDICATIONS AND USAGE**
- 2 DOSAGE AND ADMINISTRATION**
  - 2.1 Important Administration Information
  - 2.2 Dosage Information
  - 2.3 Dosage Adjustment Due to Drug Interactions
- 3 DOSAGE FORMS AND STRENGTHS**
- 4 CONTRAINDICATIONS**
- 5 WARNINGS AND PRECAUTIONS**
  - 5.1 Never Share NOVOLOG MIX 50/50 FlexPen, PenFill cartridge or PenFill Cartridge Device Between Patients
  - 5.2 Hyperglycemia or Hypoglycemia with Changes in Insulin Regimen
  - 5.3 Hypoglycemia
  - 5.4 Hypoglycemia Due to Medication Errors
  - 5.5 Hypersensitivity and Allergic Reactions
  - 5.6 Hypokalemia
  - 5.7 Fluid Retention and Heart Failure with Concomitant Use of PPAR-gamma Agonists
- 6 ADVERSE REACTIONS**
  - 6.1 Clinical Trial Experience
  - 6.2 Immunogenicity
  - 6.3 Postmarketing Experience
- 7 DRUG INTERACTIONS**
- 8 USE IN SPECIFIC POPULATIONS**
  - 8.1 Pregnancy

- 8.3 Nursing Mothers
- 8.4 Pediatric Use
- 8.5 Geriatric Use
- 8.6 Renal Impairment
- 8.7 Hepatic Impairment
- 10 OVERDOSAGE**
- 11 DESCRIPTION**
- 12 CLINICAL PHARMACOLOGY**
  - 12.1 Mechanism of Action
  - 12.2 Pharmacodynamics
  - 12.3 Pharmacokinetics
- 13 NONCLINICAL TOXICOLOGY**
  - 13.1 Carcinogenesis, Mutagenesis, Impairment of Fertility
  - 13.2 Animal Toxicology and/or Pharmacology
- 14 CLINICAL STUDIES**
  - 14.1 Clinical Studies in Adult Patients with Type 1 and Type 2 Diabetes
  - 14.2 Clinical Studies in Adult Patients with Type 2 Diabetes
- 16 HOW SUPPLIED/STORAGE AND HANDLING**
  - 16.1 How Supplied
  - 16.2 Recommended Storage
- 17 PATIENT COUNSELING INFORMATION**

\*Sections or subsections omitted from the full prescribing information are not listed.

## FULL PRESCRIBING INFORMATION

### 1 INDICATIONS AND USAGE

NOVOLOG MIX 50/50 is a mixture of insulin aspart protamine and insulin aspart indicated to improve glycemic control in patients with diabetes mellitus.

#### Limitations of Use

- NOVOLOG MIX 50/50 is not recommended for the treatment of diabetic ketoacidosis.
- The proportions of rapid-acting and intermediate insulins in NOVOLOG MIX 50/50 are fixed and do not allow for basal versus prandial dose adjustments.

### 2 DOSAGE AND ADMINISTRATION

#### 2.1 Important Administration Information

- Always check insulin labels before administration [*see Warnings and Precautions (5.4)*].
- Inject NOVOLOG MIX 50/50 subcutaneously in the abdominal region, buttocks, thigh, or upper arm.
- Administer the dose within 15 minutes before meal initiation. For patients with type 2 diabetes, the dose may also be given after meal initiation.
- Rotate injection sites within the same region from one injection to the next to reduce the risk of lipodystrophy [*see Adverse Reactions (6.1)*].
- Inspect NOVOLOG MIX 50/50 visually before use. It should appear uniformly white and cloudy. Do not use it if it looks clear or if it contains solid particles.
- NOVOLOG MIX 50/50 must be resuspended immediately before use. Resuspension is easier when the insulin has reached room temperature.
- Before inserting the NOVOLOG MIX 50/50 PenFill cartridge into a PenFill cartridge compatible delivery device, roll the cartridge in your hands in a horizontal position 10 times to mix it. Then, turn the NOVOLOG MIX 50/50 PenFill cartridge upside down so that the glass ball moves from one end of the cartridge to the other 10 times until the suspension appears uniformly white and cloudy. Inject immediately.
- When using FlexPen, roll FlexPen gently between hands in a horizontal position 10 times. Then, turn FlexPen upside down so that the glass ball moves from one end of the reservoir to the other 10 times until the suspension appears uniformly white and cloudy. Inject immediately.
- FlexPen dials in 1-unit increments.
- Use FlexPen with caution in patients with visual impairment who may rely on audible clicks to dial their dose.
- Use the PenFill cartridges with caution in patients with visual impairment.
- Do not administer NOVOLOG MIX 50/50 intravenously or use in insulin infusion pumps.
- Do not mix NOVOLOG MIX 50/50 with any other insulins.

#### 2.2 Dosage Information

- NOVOLOG MIX 50/50 may be administered up to three times daily.
- Individualize and adjust the dosage of NOVOLOG MIX 50/50 based on the individual's metabolic needs, blood glucose monitoring results and glycemic control goal.

- Dosage adjustments may be needed with changes in physical activity, changes in meal patterns (i.e., macronutrient content or timing of food intake), changes in renal or hepatic function or during acute illness [see *Warnings and Precautions (5.3) and Use in Specific Populations (8.6, 8.7)*].
- Dosage adjustment may be needed when switching from another insulin to NOVLOG MIX 50/50 [see *Warnings and Precautions (5.2)*].

### **2.3 Dosage Adjustment Due to Drug Interactions**

- Dosage adjustment may be needed when NOVLOG MIX 50/50 is coadministered with certain drugs [see *Drug Interactions (7)*].

## **3 DOSAGE FORMS AND STRENGTHS**

NOVLOG MIX 50/50 is 100 units per mL (U-100), 50% insulin aspart protamine and 50% insulin aspart, is available as a white and cloudy injectable suspension:

- 3 mL single-patient-use PenFill cartridges
- 3 mL single-patient-use NOVLOG MIX 50/50 FlexPen

## **4 CONTRAINDICATIONS**

NOVLOG MIX 50/50 is contraindicated

- During episodes of hypoglycemia [see *Warnings and Precautions (5.3)*]
- In patients with hypersensitivity to NOVLOG MIX 50/50 or one of its excipients [see *Warnings and Precautions (5.5)*]

## **5 WARNINGS AND PRECAUTIONS**

### **5.1 Never Share NOVLOG MIX 50/50 FlexPen, PenFill cartridge or PenFill Cartridge Device Between Patients**

NOVLOG MIX 50/50 FlexPen or NOVLOG MIX 50/50 PenFill cartridges in a compatible delivery device should never be shared between patients, even if the needle is changed. Sharing poses a risk for transmission of blood-borne pathogens.

### **5.2 Hyperglycemia or Hypoglycemia with Changes in Insulin Regimen**

Changes in insulin strength, manufacturer, type, or method of administration may affect glycemic control and predispose to hypoglycemia [see *Warnings and Precautions (5.3)*] or hyperglycemia. These changes should be made cautiously and only under close medical supervision, and the frequency of blood glucose monitoring should be increased. For patients with type 2 diabetes, dosage adjustments of concomitant anti-diabetic products may be needed.

### **5.3 Hypoglycemia**

Hypoglycemia is the most common adverse effect of all insulin therapies, including NOVLOG MIX 50/50. Severe hypoglycemia can cause seizures, may lead to unconsciousness, may be life threatening or cause death. Hypoglycemia can impair concentration ability and reaction time; this may place an individual and others at risk in situations where these abilities are important (e.g. driving or operating other machinery).

Hypoglycemia can happen suddenly and symptoms may differ in each individual and change over time in the same individual. Symptomatic awareness of hypoglycemia may be less pronounced in patients with longstanding diabetes in patients with diabetic nerve disease, in patients using medications that block the sympathetic nervous system (e.g., beta-blockers) [*see Drug Interactions (7)*], or in patients who experience recurrent hypoglycemia.

### Risk Factors for Hypoglycemia

The risk of hypoglycemia after an injection is related to the duration of action of the insulin and, in general, is highest when the glucose lowering effect of the insulin is maximal. As with all insulin preparations, the glucose lowering effect time course of NOVOLOG MIX 50/50 may vary in different individuals or at different times in the same individual and depends on many conditions, including the area of injection as well as the injection site blood supply and temperature [*see Clinical Pharmacology (12.2)*]. Other factors which may increase the risk of hypoglycemia include changes in meal pattern (e.g., macronutrient content or timing of meals), changes in level of physical activity, or changes to co-administered medication [*see Drug Interactions (7)*]. Patients with renal or hepatic impairment may be at higher risk of hypoglycemia [*see Use in Specific Populations (8.6, 8.7)*].

### Risk Mitigation Strategies for Hypoglycemia

Patients and caregivers must be educated to recognize and manage hypoglycemia. Self-monitoring of blood glucose plays an essential role in the prevention and management of hypoglycemia, increased frequency of blood glucose monitoring is recommended. In patients at higher risk for hypoglycemia and patients who have reduced symptomatic awareness of hypoglycemia, increased frequency of blood glucose monitoring is recommended.

#### **5.4 Hypoglycemia Due to Medication Errors**

Accidental mix-ups between NOVOLOG MIX 50/50 and other insulin products have been reported. To avoid medication errors between NOVOLOG MIX 50/50 and other insulins, instruct patients to always check the insulin label before each injection.

#### **5.5 Hypersensitivity and Allergic Reactions**

Severe, life-threatening, generalized allergy, including anaphylaxis, can occur with insulin products, including NOVOLOG MIX 50/50. If hypersensitivity reactions occur, discontinue NOVOLOG MIX 50/50; treat per standard of care and monitor until symptoms and signs resolve [*see Adverse Reactions (6)*]. NOVOLOG MIX 50/50 is contraindicated in patients who have had hypersensitivity reactions to insulin aspart or one of the excipients [*see Contraindications (4)*].

#### **5.6 Hypokalemia**

All insulin products, including NOVOLOG MIX 50/50, cause a shift in potassium from the extracellular to intracellular space, possibly leading to hypokalemia. Untreated hypokalemia may cause respiratory paralysis, ventricular arrhythmia, and death. Monitor potassium levels in patients at risk for hypokalemia if indicated (e.g., patients using potassium-lowering medications, patients taking medications sensitive to serum potassium concentration).

**5.7 Fluid Retention and Heart Failure with Concomitant Use of PPAR-gamma Agonists**  
Thiazolidinediones (TZDs), which are peroxisome proliferator-activated receptor (PPAR)-gamma agonists, can cause dose-related fluid retention, particularly when used in combination with insulin. Fluid retention may lead to or exacerbate heart failure. Patients treated with insulin, including NOVOLOG MIX 50/50, and a PPAR-gamma antagonist should be observed for signs and symptoms of heart failure. If heart failure develops, it should be managed according to current standards of care, and discontinuation or dose reduction of the PPAR-gamma agonist must be considered.

## 6 ADVERSE REACTIONS

The following adverse reactions are also discussed elsewhere:

- Hypoglycemia [see *Warnings and Precautions (5.3)*]
- Hypersensitivity and allergic reactions [see *Warnings and Precautions (5.5)*]
- Hypokalemia [see *Warnings and Precautions (5.6)*]

### 6.1 Clinical Trial Experience

Clinical trials are conducted under widely varying designs, therefore, the adverse reaction rates reported in one clinical trial may not be easily compared to those rates reported in another clinical trial, and may not reflect the rates actually observed in clinical practice.

The data in Table 1 reflect the exposure of 12 patients with type 1 diabetes to NOVOLOG MIX 50/50 with a total exposure duration of 3.3 years. The mean age was 49.6 years. Fifty percent were male and all were Caucasian. The mean body mass index (BMI) was 33.0 kg/m<sup>2</sup>. The mean duration of diabetes was 16.0 years.

The data in Table 2 reflect the exposure of 197 patients with type 2 diabetes to NOVOLOG MIX 50/50 with a total exposure duration of 57.9 years. The mean age was 59.7 years. Thirty-six percent were male and 95% were Caucasian. The mean BMI was 33.3 kg/m<sup>2</sup>. The mean duration of diabetes was 13.0 years.

Common adverse reactions defined as events occurring in  $\geq 10\%$  of the population studied are listed in Table 1 and Table 2.

**Table 1: Adverse Reactions Occuring in  $\geq 10\%$  of Type 1 Diabetes Mellitus Adult Patients Treated with NOVOLOG MIX 50/50**

	<b>NOVOLOG MIX 50/50 (N=12)</b>	<b>human premix 70/30 (N=98)</b>
	<b>%</b>	<b>%</b>
Hypoglycemia*	75	85
Headache	17	12
Upper respiratory tract infection	17	11
Infection Not Otherwise Specified	17	4

\*Hypoglycemic episodes included episodes with severe central nervous system symptoms consistent with hypoglycemia in which the subject was unable to treat himself/herself, episodes with symptoms consistent with hypoglycemia with or without a blood glucose measurement <50 mg/dl, and asymptomatic blood glucose measurements <50 mg/dl.

**Table 2: Adverse Reactions Occurring in  $\geq 10\%$  of Type 2 Diabetes Mellitus Adult Patients Treated with NOVOLOG MIX 50/50**

	<b>NOVOLOG MIX 50/50 (N=197)</b>	<b>human premix 70/30 (N=231)</b>
	<b>%</b>	<b>%</b>
Hypoglycemia*	58	55
Headache	13	11
Upper respiratory tract infection	10	12

\*Hypoglycemic episodes included episodes with severe central nervous system symptoms consistent with hypoglycemia in which the subject was unable to treat himself/herself, episodes with symptoms consistent with hypoglycemia with or without a blood glucose measurement <50 mg/dl, and asymptomatic blood glucose measurements <50 mg/dl.

### Hypoglycemia

Hypoglycemia is the most commonly observed adverse reaction in patients using insulin, including NOVOLOG MIX 50/50 [see *Warnings and Precautions (5.3)*]. The rates of reported hypoglycemia depend on the definition of hypoglycemia used, diabetes type, insulin dose, intensity of glucose control, background therapies, and other intrinsic and extrinsic patient factors. For these reasons, comparing rates of hypoglycemia in clinical trials for NOVOLOG MIX 50/50 with the incidence of hypoglycemia for other products may be misleading and also, may not be representative of hypoglycemia rates that will occur in clinical practice.

Severe hypoglycemia requiring the assistance of another person and/or parenteral glucose infusion or glucagon administration has been observed in clinical trials with insulin, including trials with NOVOLOG MIX 50/50.

### Allergic Reactions

Patients have experienced reactions such as erythema, edema or pruritus at the site of NOVOLOG MIX 50/50 injection. These reactions usually resolve in a few days to a few weeks, but in some occasions, have required discontinuation of NOVOLOG MIX 50/50.

Severe cases of generalized allergy (anaphylaxis) have been reported [see *Warnings and Precautions (5.5)*].

### Insulin initiation and glucose control intensification

Intensification or rapid improvement in glucose control has been associated with transitory, reversible ophthalmologic refraction disorder, worsening of diabetic retinopathy, and acute painful peripheral neuropathy. However, long-term glycemic control decreases the risk of diabetic retinopathy and neuropathy.

### Lipodystrophy

Long-term use of insulin, including NOVOLOG MIX 50/50, can cause lipodystrophy at the site of repeated insulin injections. Lipodystrophy includes lipohypertrophy (thickening of adipose tissue) and lipoatrophy (thinning of adipose tissue), and may affect insulin absorption [see *Dosage and Administration (2.1)*].

### Weight gain

Weight gain can occur with some insulin therapies, including NOVLOG MIX 50/50, and has been attributed to the anabolic effects of insulin and the decrease in glucosuria.

### Peripheral Edema

Insulin products, including NOVLOG MIX 50/50, may cause sodium retention and edema, particularly if previously poor metabolic control is improved by intensified insulin therapy.

## **6.2 Immunogenicity**

As with all therapeutic proteins, there is potential for immunogenicity. The detection of antibody formation is highly dependent on the sensitivity and specificity of the assay. Additionally, the observed incidence of antibody (including neutralizing antibody) positivity in an assay may be influenced by several factors including assay methodology, sample handling, timing of sample collection, concomitant medications, and underlying disease. For these reasons, comparison of the incidence of antibodies in different products may be misleading.

Antibodies specific to NOVLOG and cross-reactive with both NOVLOG and human insulin have been evaluated previously in connection with the clinical development of NOVLOG. In addition, specific anti-insulin antibodies as well as cross-reacting anti-insulin antibodies were monitored in the 3-month, open-label comparator trial between NOVLOG MIX 70/30 and human pre-mixed insulin and NOVLOG as well as in a long-term extension trial. Changes in cross-reactive antibodies were more common after NOVLOG MIX 70/30 than with human pre-mixed insulin. These changes did not correlate with loss of glycemic control or increase in insulin dose. Antibodies did not increase further after exposure of more than 6 months to NOVLOG MIX 70/30.

## **6.3 Postmarketing Experience**

Additional adverse reactions have been identified during post-approval use of NOVLOG and NOVLOG MIX 70/30. Because these adverse reactions are reported voluntarily from a population of uncertain size, it is generally not possible to reliably estimate their frequency or establish a causal relationship to drug exposure. They include medication errors in which insulins with similar names have been accidentally substituted for each other [*see Warnings and Precautions (5.4)*].

## **7 DRUG INTERACTIONS**

**Table 3: Clinically Significant Drug Interactions with NOVLOG MIX 50/50**

<b>Drugs that May Increase the Risk of Hypoglycemia</b>	
<i>Drugs:</i>	Antidiabetic agents, ACE inhibitors, angiotensin II receptor blocking agents, disopyramide, fibrates, fluoxetine, monoamine oxidase inhibitors, pentoxifylline, pramlintide, salicylates, somatostatin analog (e.g., octreotide), and sulfonamide antibiotics
<i>Intervention:</i>	Dose adjustment and increased frequency of glucose monitoring may be required when NOVLOG MIX 50/50 is co-administered with these drugs.
<b>Drugs that May Decrease the Blood Glucose Lowering Effect of NOVLOG MIX 50/50</b>	

<i>Drugs:</i>	Atypical antipsychotics (e.g., olanzapine and clozapine), corticosteroids, danazol, diuretics, estrogens, glucagon, isoniazid, niacin, oral contraceptives, phenothiazines, progestogens (e.g., in oral contraceptives), protease inhibitors, somatropin, sympathomimetic agents (e.g., albuterol, epinephrine, terbutaline), and thyroid hormones.
<i>Intervention:</i>	Dose adjustment and increased frequency of glucose monitoring may be required when NOVOLOG MIX 50/50 is co-administered with these drugs.
<b>Drugs that May Increase or Decrease the Blood Glucose Lowering Effect of NOVOLOG MIX 50/50</b>	
<i>Drugs:</i>	Alcohol, beta-blockers, clonidine, and lithium salts. Pentamidine may cause hypoglycemia, which may sometimes be followed by hyperglycemia.
<i>Intervention:</i>	Dose adjustment and increased frequency of glucose monitoring may be required when NOVOLOG MIX 50/50 is co-administered with these drugs.
<b>Drugs that May Blunt Signs and Symptoms of Hypoglycemia</b>	
<i>Drugs:</i>	Beta-blockers, clonidine, guanethidine, and reserpine
<i>Intervention:</i>	Increased frequency of glucose monitoring may be required when NOVOLOG MIX 50/50 is co-administered with these drugs.

## 8 USE IN SPECIFIC POPULATIONS

### 8.1 Pregnancy

Pregnancy Category B.

All pregnancies have a background risk of birth defects, loss, or other adverse outcome regardless of drug exposure. This background risk is increased in pregnancies complicated by hyperglycemia and may be decreased with good metabolic control. It is essential for patients with diabetes or history of gestational diabetes to maintain good metabolic control before conception and throughout pregnancy. Insulin requirements may decrease during the first trimester, generally increase during the second and third trimesters, and rapidly decline after delivery. Careful monitoring of glucose control is essential in such patients.

An open-label, randomized study compared the safety and efficacy of NOVOLOG (the rapid-acting component of NOVOLOG MIX 50/50) versus human insulin in the treatment of pregnant women with Type 1 diabetes (322 exposed pregnancies (NOVOLOG: 157, human insulin: 165)). Two-thirds of the enrolled patients were already pregnant when they entered the study. Since only one-third of the patients enrolled before conception, the study was not large enough to evaluate the risk of congenital malformations. Mean HbA<sub>1c</sub> of ~ 6% was observed in both groups during pregnancy, and there was no significant difference in the incidence of maternal hypoglycemia.

Animal reproduction studies have not been conducted with NOVOLOG MIX 50/50. However, subcutaneous reproduction and teratology studies have been performed with NOVOLOG (the rapid-acting component of NOVOLOG MIX 50/50) and regular human insulin in rats and rabbits. In these studies, NOVOLOG was given to female rats before mating, during mating, and throughout pregnancy, and to rabbits during organogenesis. The effects of NOVOLOG did not differ from those observed with subcutaneous regular human insulin. NOVOLOG caused

pre- and post-implantation losses and visceral/skeletal abnormalities in rats at a dose of 200 units/kg/day (approximately 32-times the human subcutaneous dose of 1.0 units/kg/day, based on units/body surface area), and in rabbits at a dose of 10 units/kg/day (approximately three times the human subcutaneous dose of 1.0 units/kg/day, based on units/body surface area). No significant effects were observed in rats at a dose of 50 units/kg/day and rabbits at a dose of 3 units/kg/day. These doses are approximately 8 times the human subcutaneous dose of 1.0 units/kg/day for rats and equal to the human subcutaneous dose of 1.0 units/kg/day for rabbits based on units/body surface area.

Female patients should be advised to discuss with their physician if they intend to, or if they become, pregnant. There are no adequate and well-controlled studies of the use of NOVLOG MIX 50/50 in pregnant women.

### **8.3 Nursing Mothers**

It is unknown whether NOVLOG MIX 50/50 is excreted in human milk as occurs with human insulin. There are no adequate and well-controlled studies of the use of NOVLOG MIX 50/50 or NOVLOG in lactating women. Women with diabetes who are lactating may require adjustments of their insulin doses.

### **8.4 Pediatric Use**

Safety and effectiveness of NOVLOG MIX 50/50 have not been established in pediatric patients.

### **8.5 Geriatric Use**

Clinical studies of NOVLOG MIX 50/50 did not include sufficient numbers of patients aged 65 and over to determine whether they respond differently than younger patients. In elderly patients with diabetes, the initial dosing, dose increments should be conservative to avoid hypoglycemic reactions. Hypoglycemia may be difficult to recognize in the elderly.

### **8.6 Renal Impairment**

The effect of renal impairment on the pharmacokinetics of NOVLOG MIX 50/50 has not been studied. Some studies with human insulin have shown increased circulating levels of insulin in patients with renal failure. Patients with renal impairment may be at increased risk of hypoglycemia and may require more frequent NOVLOG MIX 50/50 dose adjustment and more frequent blood glucose monitoring [*see Warnings and Precautions (5.3)*].

### **8.7 Hepatic Impairment**

The effect of hepatic impairment on the pharmacokinetics of NOVLOG MIX 50/50 has not been studied. Patients with hepatic impairment may be at increased risk of hypoglycemia and may require more frequent NOVLOG MIX 50/50 dose adjustment and more frequent blood glucose monitoring [*see Warnings and Precautions (5.3)*].

## **10 OVERDOSAGE**

Excess insulin administration may cause hypoglycemia and hypokalemia [*see Warnings and Precautions (5.3, 5.6)*]. Mild episodes of hypoglycemia usually can be treated with oral glucose. Adjustments in drug dosage, meal patterns, or exercise, may be needed. More severe episodes with coma, seizure, or neurologic impairment may be treated with intramuscular/subcutaneous

glucagon or concentrated intravenous glucose. Sustained carbohydrate intake and observation may be necessary because hypoglycemia may recur after apparent clinical recovery. Hypokalemia must be corrected appropriately.

## 11 DESCRIPTION

NOVOLOG MIX 50/50 (insulin aspart protamine suspension and insulin aspart injection) is a human insulin analog suspension containing 50% insulin aspart protamine crystals and 50% soluble insulin aspart. NOVOLOG MIX 50/50 is a blood glucose-lowering agent with an earlier onset and an intermediate duration of action. Insulin aspart is homologous with regular human insulin with the exception of a single substitution of the amino acid proline by aspartic acid in position B28, and is produced by recombinant DNA technology utilizing *Saccharomyces cerevisiae* (baker's yeast). Insulin aspart (NOVOLOG) has the empirical formula  $C_{256}H_{381}N_{65}O_{79}S_6$  and a molecular weight of 5825.8 Da.

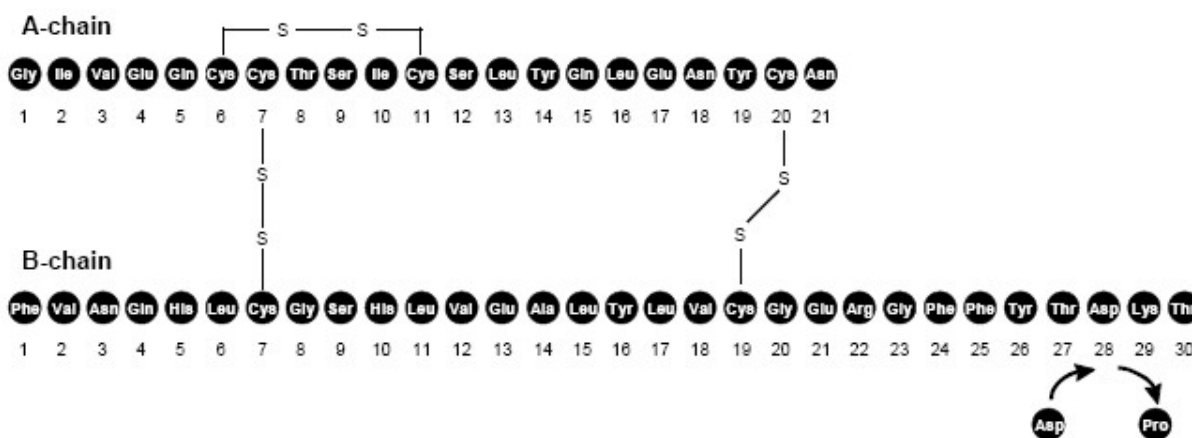

**Figure 1. Structural formula of insulin aspart**

NOVOLOG MIX 50/50 is a uniform, white, sterile suspension that contains insulin aspart 100 units/mL. Inactive ingredients are glycerol 16.0 mg/mL, phenol 1.50 mg/mL, metacresol 1.72 mg/mL, zinc 19.6  $\mu$ g/mL, disodium hydrogen phosphate dihydrate 1.25 mg/mL, sodium chloride 0.877 mg/mL, and protamine sulfate 0.32 mg/mL. NOVOLOG MIX 50/50 has a pH of 7.20 - 7.44. Hydrochloric acid or sodium hydroxide may be added to adjust pH.

## 12 CLINICAL PHARMACOLOGY

### 12.1 Mechanism of Action

The primary activity of insulin, including NOVOLOG MIX 50/50 is the regulation of glucose metabolism. Insulin and its analog lower blood glucose by stimulating peripheral glucose uptake, especially by skeletal muscle and fat, and by inhibiting hepatic glucose production. Insulin inhibits lipolysis and proteolysis, and enhances protein synthesis.

### 12.2 Pharmacodynamics

In an euglycemic clamp study in subjects with type 1 diabetes (n=32), a maximum glucose infusion rate ( $GIR_{max}$ ) of  $6.0 \pm 1.7$  mg/kg/min was reached after approximately 2.5 hours for NOVOLOG MIX 50/50 (See Figure 2) administered as a single subcutaneous dose of 0.4

units/kg. On average, the duration of action was approximately 13 hours for NOVOLOG MIX 50/50 after single subcutaneous dose with 0.4 units/kg. The overall pharmacodynamic effect measured as  $AUC_{GIR\ 0-12h}$  was on average 1901 mg/kg for 0.4 units/kg dose of NOVOLOG MIX 50/50. There was diminishing distinction in pharmacodynamics between the two NOVOLOG MIX formulations at later time points (See Figure 2). The  $GIR_{max}$  and  $AUC_{GIR,0-2h}$  were greater for NOVOLOG MIX 50/50 than for NOVOLOG MIX 70/30 and were less for NOVOLOG MIX 50/50 than for NOVOLOG (See Table 4).

**Table 4: Pharmacodynamic Parameters comparing NOVOLOG® MIX 50/50 to NOVOLOG® MIX 70/30 and NOVOLOG® in patients with Type 1 diabetes mellitus**

	NOVOLOG MIX 50/50 versus NOVOLOG MIX 70/30	NOVOLOG versus NOVOLOG MIX 50/50
$GIR_{max}$	1.29 [1.17; 1.43]	1.49 [1.35; 1.65]
$AUC_{GIR,0-2h}$	1.52 [1.31; 1.78]	1.44 [1.23; 1.67]

Values are expressed as mean ratios [95% confidence intervals]

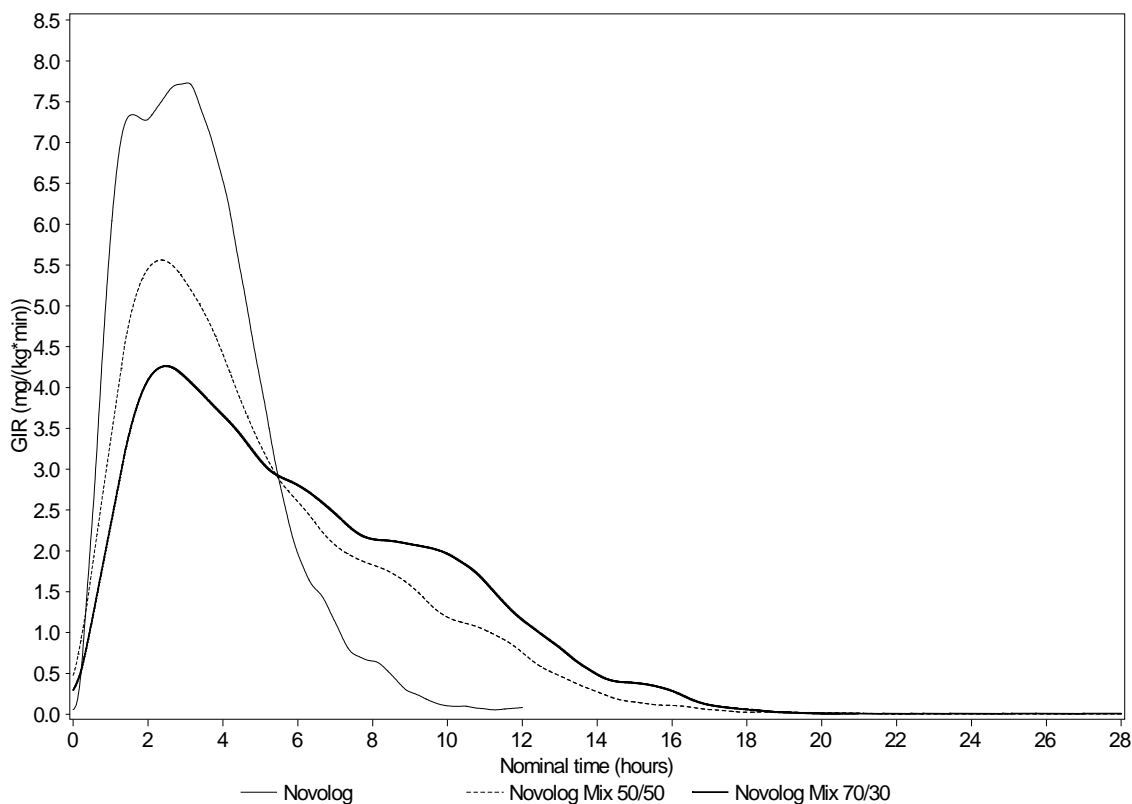

x14/sum5070-us/current - 07SEP2007 - f\_fda\_sep\_07\_1746.sas/fda\_sep\_07/f\_fda\_sep\_07\_1746\_gir.ogm

**Figure 2. Pharmacodynamic profiles of NOVOLOG MIX 50/50, 70/30, and NOVOLOG in patients with Type 1 diabetes mellitus following single subcutaneous dose of 0.4 units/kg**

### 12.3 Pharmacokinetics

The single substitution of the amino acid proline with aspartic acid at position B28 in insulin aspart (NOVOLOG) reduces the molecule's tendency to form hexamers as observed with regular human insulin. The rapid absorption characteristics of NOVOLOG are maintained by NOVOLOG MIX 50/50.

*Absorption and Bioavailability*

In an euglycemic clamp study in patients with type 1 diabetes (n=32) after dosing with 0.4 units/kg of NOVOLOG MIX 70/30, 50/50, and NOVOLOG on three different study days, a  $C_{max}$  of  $98 \pm 29$  milliunits/L was reached after approximately 80 minutes for NOVOLOG MIX 50/50 (See Figure 3). There was diminishing distinction in pharmacokinetics between the two NOVOLOG MIX formulations at later time points (See Figure 3). The  $C_{max}$  and  $AUC_{0-2h}$  were greater for NOVOLOG MIX 50/50 than for NOVOLOG MIX 70/30 and were less for NOVOLOG MIX 50/50 than for NOVOLOG (See Table 5).

**Table 5: Pharmacokinetic Parameters comparing NOVOLOG MIX 50/50 to NOVOLOG MIX 70/30 and NOVOLOG in patients with Type 1 diabetes mellitus**

	NOVOLOG MIX 50/50 versus NOVOLOG MIX 70/30	NOVOLOG versus NOVOLOG MIX 50/50
$C_{max}$	1.49 [1.34; 1.65]	2.04 [1.84; 2.26]
$AUC_{0-2h}$	1.48 [1.35; 1.64]	2.01 [1.82; 2.22]

Values are expressed as mean ratios [95% confidence intervals]

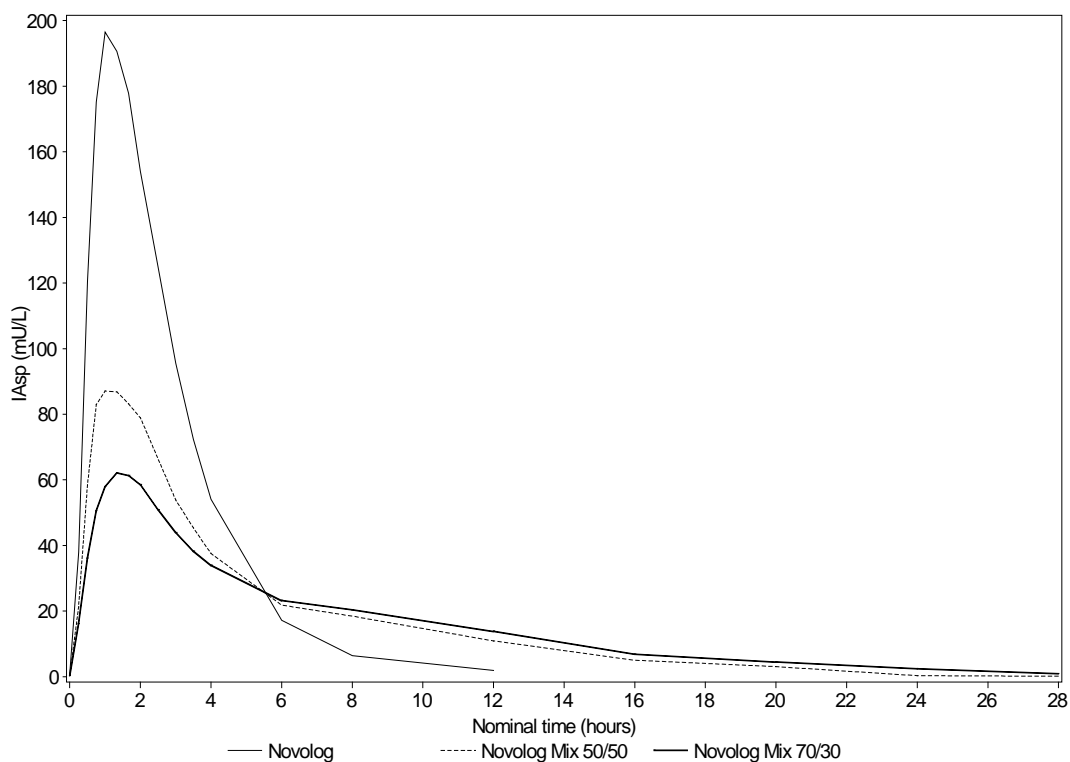

x14sum6070-us/current - 07SEP2007 - f\_lda\_sep\_07\_1746.sas/fda\_sep\_07/f\_lda\_sep\_07\_1746\_iasp.cgm

**Figure 3. Pharmacokinetic profiles of NOVOLOG MIX 50/50, 70/30, and NOVOLOG in Patients with Type 1 diabetes mellitus following single subcutaneous dose of 0.4 units/kg**

#### *Distribution and Elimination*

NOVOLOG MIX 50/50 is a biphasic insulin which contains 50% soluble insulin aspart. Insulin Aspart has a low binding to plasma proteins, 0 – 9%, similar to regular human insulin. After subcutaneous administration of NOVOLOG MIX 50/50 in patients with type 1 diabetes (n=32), insulin aspart concentrations declined with an average apparent half-life of 5.5 hours.

### **13 NONCLINICAL TOXICOLOGY**

#### **13.1 Carcinogenesis, Mutagenesis, Impairment of Fertility**

Standard 2-year carcinogenicity studies in animals have not been performed to evaluate the carcinogenic potential of NOVOLOG MIX 50/50. In 52-week studies, Sprague-Dawley rats were dosed subcutaneously with NOVOLOG, the rapid-acting component of NOVOLOG MIX 50/50, at 10, 50, and 200 units/kg/day (approximately 2, 8, and 32 times the human subcutaneous dose of 1.0 unit/kg/day, based on units/body surface area, respectively). At a dose of 200 units/kg/day, NOVOLOG increased the incidence of mammary gland tumors in females when compared to untreated controls. The relevance of these findings to humans is not known.

NOVOLOG was not genotoxic in the following tests: Ames test, mouse lymphoma cell forward gene mutation test, human peripheral blood lymphocyte chromosome aberration test, *in vivo* micronucleus test in mice, and in *ex vivo* UDS test in rat liver hepatocytes.

In fertility studies in male and female rats, NOVLOG at subcutaneous doses up to 200 units/kg/day (approximately 32 times the human subcutaneous dose, based on units/body surface area) had no direct adverse effects on male and female fertility, or on general reproductive performance of animals.

### 13.2 Animal Toxicology and/or Pharmacology

In standard biological assays in mice and rabbits, one unit of NOVLOG has the same glucose-lowering effect as one unit of regular human insulin.

## 14 CLINICAL STUDIES

### 14.1 Clinical Studies in Adult Patients with Type 1 and Type 2 Diabetes

In a 16-week, randomized, open-label trial, patients with type 1 diabetes (n = 32) or type 2 diabetes (n = 207) and BMI > 30 kg/m<sup>2</sup> were treated with twice daily (breakfast and supper) Novolin 70/30 or three times daily (each meal) NOVLOG MIX 50/50. Subjects with pre-breakfast blood glucose levels > 144 mg/dL within the first 2-6 weeks of treatment in the NOVLOG MIX 50/50 arm had their supper-time dose switched to NOVLOG MIX 70/30 to prolong basal insulin coverage.

In the study, the results of the three times daily NOVLOG MIX 50/50-treated patients with type 2 diabetes showed HbA<sub>1c</sub> values that were significantly lower (p < 0.05) compared to subjects treated with Novolin 70/30 (see Table 6 for glycemic parameters at baseline and end of treatment). Mean HbA<sub>1c</sub> values were not significantly different between treatments at the end of the study for subjects with type 1 diabetes.

**Table 6: Glycemic Parameters in a 16-week study in Adult Patients with Type 1 and Type 2 Diabetes**

	NOVLOG MIX 50/50	Novolin 70/30
<b>Glycemic Parameters at Baseline [Mean (SD)]</b>		
Type 1 (BMI > 30 kg/m <sup>2</sup> )	N=12	N=20
Fasting Blood Glucose (mg/dL)	172.8 (34.20)	142.2 (39.60)
1.5 Hour Post Breakfast	194.4 (73.80)	201.6 (63.00)
1.5 Hour Post Lunch	169.2 (54.00)	174.6 (55.80)
1.5 Hour Post Dinner	181.8 (84.60)	214.2 (82.80)
HbA <sub>1c</sub> (%)	8.3 (1.90)	8.6 (0.90)
Type 2 (BMI > 30 kg/m <sup>2</sup> )	N=103	N=104
Fasting Blood Glucose (mg/dL)	174.6 (61.20)	178.2 (63.00)
1.5 Hour Post Breakfast	250.2 (84.60)	261.0 (88.20)
1.5 Hour Post Lunch	216.0 (75.60)	232.2(77.40)
1.5 Hour Post Dinner	225.0 (73.80)	228.6 (81.00)
HbA <sub>1c</sub> (%)	8.7 (1.70)	9.0 (1.60)
<b>Glycemic Parameters at the End of Treatment [Estimated Mean (SEM)]</b>		
Type 1 (BMI > 30 kg/m <sup>2</sup> )	N=12	N=20
Fasting Blood Glucose (mg/dL)	160.35 (15.39)	155.63 (9.92)
1.5 Hour Post Breakfast	146.68 (25.62)	210.26 (17.06)
1.5 Hour Post Lunch	167.12 (26.07)	187.12 (17.38)
1.5 Hour Post Dinner	138.89 (22.25)	179.87 (14.81)

HbA <sub>1c</sub> (%)	8.53 (0.27)	8.86 (0.19)
Type 2 (BMI > 30 kg/m <sup>2</sup> )	N=103	N=104
Fasting Blood Glucose (mg/dL)	166.75 (4.19)	155.50 (4.34)
1.5 Hour Post Breakfast	196.89 (6.36)*	219.91 (6.52)
1.5 Hour Post Lunch	174.02 (6.70)*	199.64 (6.86)
1.5 Hour Post Dinner	176.75 (6.76)*	211.70 (7.01)
HbA <sub>1c</sub> (%)	8.38 (0.09)*	8.78 (0.09)

Values are based on an ANOVA for Glycemic Parameters at the End of Treatment

\*p<0.05 between treatments at the End of Treatment

## 14.2 Clinical Studies in Adult Patients with Type 2 Diabetes

A 16 week, , open-label parallel group trial randomized patients with type 2 diabetes to NOVOLOG MIX 50/50 with breakfast and lunch and NOVOLOG MIX 70/30 with dinner versus basal bolus treatment with insulin aspart at mealtimes and NPH at bedtime (Table 7). Three daily injections with NOVOLOG MIX formulations provided glycemic control (as measured by HbA<sub>1c</sub>) that was non-inferior to that obtained by four daily injections in basal bolus treatment with insulin aspart plus NPH.

**Table 7: Glycemic Parameters at baseline and the End of Treatment [Mean ± (SD)]**

	NOVOLOG MIX 50/50	IAsp + NPH
Type 2 (BMI > 30 kg/m <sup>2</sup> )		
Baseline	N=94	N=89
HbA <sub>1c</sub> (%)	9.1 ± 0.7	9.0 ± 0.7
End-of-Study	N=88	N=84
HbA <sub>1c</sub> (%)	7.8 ± 1.1	7.8 ± 1.0

## 16 HOW SUPPLIED/STORAGE AND HANDLING

### 16.1 How Supplied

NOVOLOG MIX 50/50 100 units per mL (U-100), 50% insulin aspart protamine and 50% insulin aspart, is available as a white and cloudy injectable suspension:

3 mL single-patient-use PenFill cartridges*	NDC 0169-XXXX-XX
3 mL single-patient-use NOVOLOG MIX 50/50 FlexPen	NDC 0169-XXXX-XX

\* NOVOLOG MIX 50/50 PenFill cartridges are designed for use with Novo Nordisk 3 mL PenFill cartridge compatible insulin delivery devices and NovoFine disposable needles.

FlexPen dials in 1-unit increments.

### 16.2 Recommended Storage

Unused NOVOLOG MIX 50/50 should be stored in a refrigerator between 2°C and 8°C (36°F to 46°F).

- **Do not freeze NOVOLOG MIX 50/50.**

- Do not use NOVOLOG MIX 50/50 if it has been frozen.
- Do not expose NOVOLOG MIX 50/50 to excessive heat or light.

Always remove the needle after each injection and store NOVOLOG MIX 50/50 FlexPen without a needle attached. Always use a new needle for each injection to prevent contamination.

The storage conditions are summarized in the following table:

	Not in-use (unopened) Room Temperature (below 30° C [86° F])	Not in-use (unopened) Refrigerated (2° C - 8° C [36° F- 46° F])	In-use (opened) Room Temperature (below 30° C [86° F])
3 mL NOVOLOG MIX 50/50 PenFill	14 days	Until expiration date	14 days (Do not refrigerate)
3 mL NOVOLOG MIX 50/50 FlexPen	14 days	Until expiration date	14 days (Do not refrigerate)

## 17 PATIENT COUNSELING INFORMATION

Advise the patient to read the *FDA-approved patient labeling* (Patient Information and Instructions for Use).

### Never Share a NOVOLOG MIX 50/50 FlexPen between Patients

Advise patients that they must never share NOVOLOG MIX 50/50 FlexPen or PenFill cartridge used in a compatible insulin delivery device with another person even if the needle is changed. Sharing poses a risk for transmission of blood-borne pathogens [see *Warnings and Precautions (5.1)*].

### Hypoglycemia

Inform patients that hypoglycemia is the most common adverse reaction with insulin. Instruct patients on self-management procedures including glucose monitoring, proper injection technique, and management of hypoglycemia and hyperglycemia, especially at initiation of NOVOLOG MIX 50/50 therapy. Instruct patients on handling of special situations such as intercurrent conditions (illness, stress, or emotional disturbances), an inadequate or skipped insulin dose, inadvertent administration of an increased insulin dose, inadequate food intake, and skipped meals. Instruct patients on the management of hypoglycemia [see *Warnings and Precautions (5.3)*].

Inform patients that their ability to concentrate and react may be impaired as a result of hypoglycemia. Advise patients who have frequent hypoglycemia or reduced or absent warning signs of hypoglycemia to use caution when driving or operating machinery.

### Hypoglycemia with Medication Errors

Instruct patients to always check the insulin label before each injection to avoid mix-ups between insulin products [see *Warnings and Precautions (5.4)*].

### Hypersensitivity Reactions

Advise patients that hypersensitivity reactions have occurred with NOVOLOG MIX 50/50. Inform patients of the symptoms of hypersensitivity reactions [see *Warnings and Precautions (5.5)*].

### Administration

- Advise patients to inspect NOVOLOG MIX 50/50 visually before use. It should appear uniformly white and cloudy. Instruct them to not use it if it looks clear or contains solid particles.
- NOVOLOG MIX 50/50 must be resuspended immediately before use. Resuspension is easier when the insulin has reached room temperature.
- Before inserting the NOVOLOG MIX 50/50 PenFill cartridge into a PenFill cartridge compatible delivery device, instruct patients to roll the cartridge in their hands in a horizontal position 10 times to mix it. Then, turn the NOVOLOG MIX 50/50 PenFill cartridge upside down so that the glass ball moves from one end of the cartridge to the other 10 times until the suspension appears uniformly white and cloudy. The patient should use immediately after resuspension.
- Instruct patients when using FlexPen, to roll FlexPen gently between their hands in a horizontal position 10 times. Then, to turn FlexPen upside down so that the glass ball moves from one end of the reservoir to the other 10 times until the suspension appears uniformly white and cloudy. The patient should use immediately after resuspension.
- Instruct patients to administer NOVOLOG MIX 50/50 by subcutaneous injection in the abdominal region, buttocks, thigh, or upper arm and to rotate injection sites within the same region to reduce the risk of lipodystrophy.

Version: X

*Novo Nordisk®*, *NOVOLOG®*, *FlexPen®*, *PenFill®* and *Novolin®* are registered trademarks of *Novo Nordisk® A/S*.

Patent Information: <http://novonordisk-us.com/patients/products/product-patents.html>

© 2008 – 201X Novo Nordisk

Manufactured by:  
Novo Nordisk A/S  
DK-2880 Bagsvaerd, Denmark

For information about NOVOLOG MIX 50/50 contact:  
Novo Nordisk Inc.  
800 Scudders Mill Road  
Plainsboro, New Jersey 08536  
1-800-727-6500

[www.novonordisk-us.com](http://www.novonordisk-us.com)

Patient Information for NovoLog® Mix 50/50

## **NovoLog® Mix 50/50**

(insulin aspart protamine and insulin aspart injectable suspension)

### **Important:**

**Know your insulin.** Do not change the type of insulin you take unless told to do so by your healthcare provider. The amount of insulin you take as well as the best time for you to take your insulin may need to change if you take a different type of insulin.

Make sure you have the type and strength of insulin prescribed for you.

Read this Patient Information that comes with NovoLog® Mix 50/50 before you start taking it and each time you get a refill. There may be new information since your last refill. This leaflet does not take the place of talking with your healthcare provider about your diabetes or your treatment. Make sure that you know how to manage your diabetes. Ask your healthcare provider if you have any questions about managing your diabetes.

**Do not share your NovoLog Mix 50/50 PenFill cartridges, PenFill cartridge compatible insulin delivery devices, and NovoLog Mix 50/50 FlexPen Prefilled syringes with other people, even if the needle has been changed. You may give other people a serious infection, or get a serious infection from them.**

### **What is NovoLog® Mix 50/50?**

NovoLog® Mix 50/50 is both a rapid-acting and long-acting man-made insulin.

NovoLog® Mix 50/50 comes in:

- 3 mL PenFill® cartridges.
- 3 mL NovoLog® Mix 50/50 FlexPen® Prefilled syringe.

Only use NovoLog® Mix 50/50 if all of the medicine looks white and cloudy after you mix it (resuspension) (see “Patient Instructions for Use”). If your NovoLog® Mix 50/50 looks clear, do not use it and call Novo Nordisk at 1-800-727-6500.

### **Who should not take NovoLog® Mix 50/50?**

#### **Do not use NovoLog® Mix 50/50 if:**

- Your blood sugar is too low (hypoglycemia). After treating your low blood sugar, follow your healthcare provider's instructions on the use of NovoLog® Mix 50/50.
- You are allergic to anything in NovoLog® Mix 50/50. See the end of this leaflet for a complete list of ingredients in NovoLog® Mix 50/50. Check with your healthcare provider if you are not sure.

### **Tell your healthcare provider:**

- **about all of your medical conditions.** Medical conditions can affect your insulin needs and your dose of NovoLog<sup>®</sup> Mix 50/50.
- **if you are pregnant or breast feeding.** You and your healthcare provider should talk about the best way to manage your diabetes while you are pregnant or breastfeeding. NovoLog<sup>®</sup> Mix 50/50 has not been studied in pregnant or nursing women.
- **about all of the medicines you take,** including prescription and non-prescription medicines, vitamins and herbal supplements. Many medicines can affect your blood sugar levels and your insulin needs. Your NovoLog<sup>®</sup> Mix 50/50 dose may need to change if you take other medicines.
- **if you take any other medicines, especially ones commonly called TZDs (thiazolidinediones).**
- **if you have heart failure or other heart problems.** If you have heart failure, it may get worse while you take TZDs with NovoLog<sup>®</sup> Mix 50/50.

Know the medicines you take. Keep a list of your medicines with you to show all your healthcare providers.

### **How should I take NovoLog<sup>®</sup> Mix 50/50?**

**Read the instructions for use that come with your NovoLog<sup>®</sup> Mix 50/50 product.** Talk to your healthcare provider if you have any questions. Your healthcare provider should show you how to inject NovoLog<sup>®</sup> Mix 50/50 before you start taking it.

- **Take NovoLog<sup>®</sup> Mix 50/50 exactly as prescribed.** NovoLog<sup>®</sup> Mix 50/50 is injected right before a meal, up to three (3) times each day.
- **NovoLog<sup>®</sup> Mix 50/50 starts acting fast, so inject it up to 15 minutes before you eat a meal.** Do not inject NovoLog<sup>®</sup> Mix 50/50 if you are not planning to eat within 15 minutes.
- **Inject NovoLog<sup>®</sup> Mix 50/50 under the skin of your stomach area, upper arms, or upper legs.** NovoLog<sup>®</sup> Mix 50/50 may affect your blood sugar levels sooner if you inject it into the skin of your stomach area.
- **Change (rotate) sites with each dose. Although you can inject insulin in the same area, do not inject into the exact same spot for each injection.**
- **Check your blood sugar levels.** Ask your healthcare provider how often you should check your blood sugar levels for hypoglycemia (too low blood sugar) and hyperglycemia (too high blood sugar).
- **If you take too much NovoLog<sup>®</sup> Mix 50/50, your blood sugar may fall low (hypoglycemia).** You can treat mild low blood sugar (hypoglycemia) by drinking or eating something sugary right away (fruit juice, sugar candies, or glucose tablets). It is important to treat low blood sugar

(hypoglycemia) right away because it could get worse and you could pass out (become unconscious). If you pass out you will need help from another person or emergency medical services right away, and will need treatment with a glucagon injection or treatment at a hospital. See “What are the most common side effects of NovoLog® Mix 50/50?” for more information on low blood sugar (hypoglycemia).

- **If you forget to take your dose of NovoLog® Mix 50/50, your blood sugar may go too high (hyperglycemia).** High blood sugar (hyperglycemia) if not treated can lead to loss of consciousness (passing out), coma or even death. Symptoms of high blood sugar may include:
  - increased thirst
  - frequent urination
  - drowsiness
  - loss of appetite
  - fruity odor on the breath
  - high amounts of sugar and ketones in your urine
  - nausea, vomiting (throwing up), or abdominal pain
  - a hard time breathing

Follow your healthcare provider’s instructions for treating high blood sugar, and talk to your healthcare provider if high blood sugar is a problem for you.

- **Do not share your NovoLog Mix 50/50 PenFill cartridges, PenFill cartridge compatible insulin delivery devices, and NovoLog Mix 50/50 FlexPen Prefilled syringes with other people, even if the needle has been changed. You may give other people a serious infection, or get a serious infection from them.**
- Do not reuse or share your needles with other people. You may give other people a serious infection, or get a serious infection from them.

**Your insulin dosage may need to change because of:**

- illness
- stress
- other medicines you take
- change in food intake
- change in physical activity or exercise
- surgery

Follow your healthcare provider’s instructions to make changes in your insulin dose.

- **Never mix NovoLog® Mix 50/50 with other insulin products.**
- **Never use NovoLog® Mix 50/50 in an insulin pump.**
- **Never inject NovoLog® Mix 50/50 into a vein.**

See the end of this patient information for instructions about preparing and giving the injection.

## What are the most common side effects of NovoLog® Mix 50/50?

▪ **Low blood sugar (hypoglycemia).** Symptoms of low blood sugar may include:

- sweating
- dizziness or lightheadedness
- shakiness
- hunger
- fast heart beat
- tingling of lips or tongue
- trouble concentrating or confusion
- blurred vision
- slurred speech
- anxiety, irritability or mood changes
- headache

Alcohol, including beer and wine, may affect your blood sugar when you take NovoLog® Mix 50/50.

Your ability to concentrate or react may be reduced if you have hypoglycemia. Be careful when you drive a car or operate machinery. Ask your healthcare provider if you should drive if you have:

- frequent hypoglycemia
- reduced or absent warning signs of hypoglycemia

Severe low blood sugar can cause unconsciousness (passing out), seizures, and death. Know your symptoms of low blood sugar. Follow your healthcare provider's instructions for treating low blood sugar. Talk to your healthcare provider if low blood sugar is a problem for you.

Call your doctor for medical advice about side effects. You may report side effects to FDA at 1-800-FDA-1088.

### Other possible side effects include:

- **Serious allergic reaction (whole body allergic reaction).** Get medical help right away if you develop a rash over your whole body, have trouble breathing, a fast heartbeat, or sweating.
- **Reactions at the injection site (local allergic reaction).** You may get redness, swelling and itching at the injection site. If you keep having skin reactions or they are serious, you may need to stop taking NovoLog® Mix 50/50 and take a different insulin. Do not inject insulin into a skin area that is red, swollen, or itchy.
- **Skin thickens or pits at the injection site (lipodystrophy).** Change (rotate) where you inject your insulin to help prevent these skin changes from happening. Do not inject insulin into this type of skin.
- **Swelling of your hands and feet.**
- **Heart Failure.** Taking certain diabetes pills called thiazolidinediones or "TZDs" with NovoLog® Mix 50/50 may cause heart failure in some people. This can happen even if you have never had heart failure or heart

problems before. If you already have heart failure it may get worse while you take TZDs with NovoLog<sup>®</sup> Mix 50/50. Your healthcare provider should monitor you closely while you are taking TZDs with NovoLog<sup>®</sup> Mix 50/50. Tell your healthcare provider if you have any new or worse symptoms of heart failure including:

- shortness of breath
- swelling of your ankles or feet
- sudden weight gain

Treatment with TZDs and NovoLog<sup>®</sup> Mix 50/50 may need to be adjusted or stopped by your healthcare provider if you have new or worse heart failure.

- **Low potassium in your blood (hypokalemia).**

These are not all of the possible side effects from NovoLog<sup>®</sup> Mix 50/50. Ask your healthcare provider or pharmacist for more information.

### **How should I store NovoLog<sup>®</sup> Mix 50/50?**

#### **Unopened NovoLog<sup>®</sup> Mix 50/50:**

- Keep all unopened NovoLog<sup>®</sup> Mix 50/50 in the refrigerator between 36° to 46° F (2° to 8° C). Do not store in the freezer or next to the refrigerator cooling element. **Do not freeze.**
- Keep unopened NovoLog<sup>®</sup> Mix 50/50 in the carton to protect from light.

#### **After the package has been opened:**

- Do not put NovoLog<sup>®</sup> Mix 50/50 that you are using in the refrigerator. Keep at room temperature at or below 86°F (30°C) for up to 14 days.
- Keep NovoLog<sup>®</sup> Mix 50/50 away from direct heat or light.
- Throw away used NovoLog<sup>®</sup> Mix 50/50 after 14 days of use, even if there is insulin left in the cartridge or syringe.

### **General information about NovoLog<sup>®</sup> Mix 50/50**

Medicines are sometimes prescribed for conditions that are not mentioned in the patient leaflet. Do not use NovoLog<sup>®</sup> Mix 50/50 for a condition for which it was not prescribed. Do not give NovoLog<sup>®</sup> Mix 50/50 to other people, even if they have the same symptoms you have. It may harm them.

This leaflet summarizes the most important information about NovoLog<sup>®</sup> Mix 50/50. If you would like more information about NovoLog<sup>®</sup> Mix 50/50 or diabetes, talk with your healthcare provider. You can ask your healthcare provider or pharmacist for information about NovoLog<sup>®</sup> Mix 50/50 which is written for healthcare professionals. For more information, call 1-800-727-6500 or visit [www.novonordisk-us.com](http://www.novonordisk-us.com).

Helpful information for people with diabetes is published by the American Diabetes Association, 1660 Duke Street, Alexandria, VA 22314 and on [www.diabetes.org](http://www.diabetes.org).

**What are the ingredients in NovoLog® Mix 50/50?**

- insulin aspart
- glycerol
- phenol
- metacresol
- protamine sulfate
- zinc
- disodium hydrogen phosphate dihydrate
- sodium chloride
- hydrochloric acid and/or sodium hydroxide may be added

Date of Issue: XXX 2017

Version: X

*NovoLog®, PenFill®, FlexPen®, and NovoFine®, are registered trademarks of Novo Nordisk A/S.*

PATENT Information: <http://novonordisk-us.com/patients/products/product-patents.html>

© 2017 Novo Nordisk

Manufactured by:  
Novo Nordisk A/S  
DK-2880 Bagsvaerd, Denmark

For information about NovoLog® Mix 50/50 contact:  
Novo Nordisk Inc.  
800 Scudders Mill Road  
Plainsboro, New Jersey 08536

## Instructions for Use

### NovoLog® Mix 50/50 FlexPen® Prefilled syringe

#### How to use the NovoLog Mix 50/50 FlexPen Prefilled syringe

**Do not share your NovoLog Mix 50/50 Prefilled syringe with other people, even if the needle has been changed. You may give other people a serious infection, or get a serious infection from them.**

NovoLog Mix 50/50 FlexPen Prefilled syringe is a disposable insulin delivery system. NovoLog Mix 50/50 FlexPen Prefilled syringe is to be used with NovoFine® single use needles.

People who are blind or have vision problems should not use the NovoLog Mix 50/50 FlexPen Prefilled syringe without help from a person trained to use the NovoLog Mix 50/50 FlexPen Prefilled syringe.

**Please read these instructions completely before using this device.**

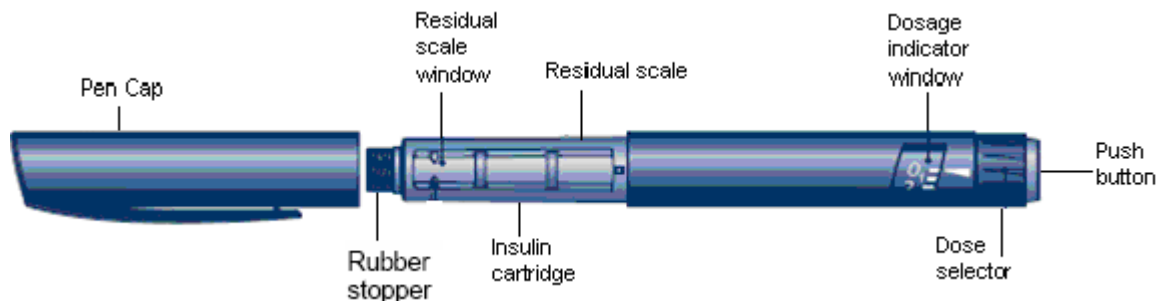

Figure 1 Diagram of a NovoLog Mix 50/50 FlexPen Prefilled syringe

#### NovoFine® needle

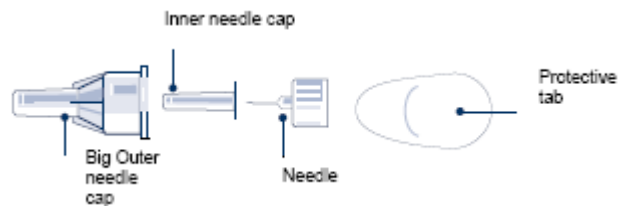
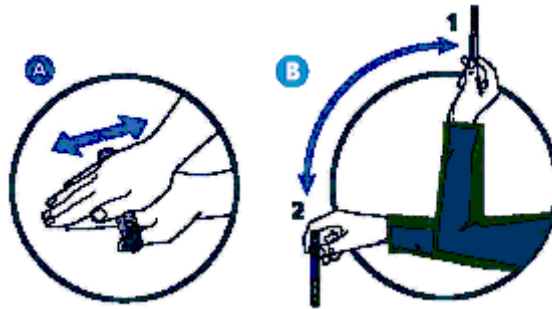

Figure 2 Diagram of a NovoFine needle

## 1. PREPARING THE NOVOLOG MIX 50/50 FLEXPEN PREFILLED SYRINGE

Before you start to prepare your injection, check the label to make sure that you are taking the right type of insulin. NovoLog Mix 50/50 should look white and cloudy (after being mixed). This is especially important if you use 2 types of insulin.

- Pull off the pen cap.
- Wipe the rubber stopper with an alcohol swab.



- Before using a new NovoLog Mix 50/50 FlexPen Prefilled syringe for the first time, do the following to mix (resuspend) the insulin:
  - Hold the NovoLog Mix 50/50 FlexPen Prefilled syringe in a horizontal (flat) position between your palms (see diagram A above). Roll the NovoLog Mix 50/50 FlexPen Prefilled syringe between your palms 10 times.
  - Then, turn the NovoLog Mix 50/50 FlexPen Prefilled syringe up and down. Move the NovoLog Mix 50/50 FlexPen Prefilled syringe between position 1 and 2 so that the glass ball moves from one end of the insulin cartridge to the other (see diagram B above). Do this at least 10 times. Repeat the rolling and turning steps until all of the insulin looks white and cloudy. Mixing (resuspension) is easier when the insulin is at room temperature.
  - After mixing, continue to do the following steps right away. If there is a delay, the insulin will need to be mixed again.

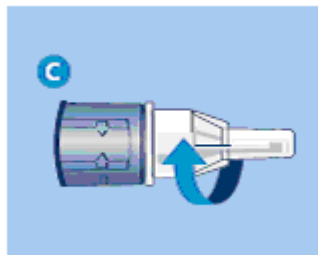

- Remove the protective tab from the disposable needle and screw the needle tightly onto the NovoLog Mix 50/50 FlexPen Prefilled syringe (see diagram C above). Do not place a disposable needle on your NovoLog Mix 50/50 FlexPen Prefilled syringe until you are ready to take your injection.

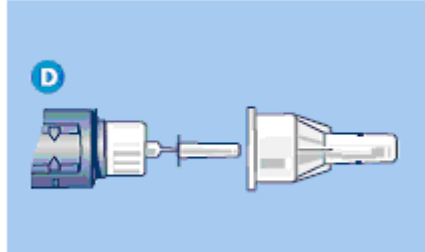

- Pull off the outer and inner needle caps (see diagram D above). Do not throw away the big outer needle cap.
- **Giving the airshot before each injection:**  
Small amounts of air may collect in the needle and insulin cartridge during normal use. **To avoid injecting air and to make sure you take the right dose of insulin**, do the following:
  - **Dial 2 units by turning the dose selector so that the arrow lines up with the “2” in the dosage indicator window (see diagram E below).**
  - **Hold the NovoLog Mix 50/50 FlexPen Prefilled syringe with the needle pointing up. Tap the insulin cartridge gently with your finger a few times (see diagram F below).** A small air bubble may remain but it will not be injected. The NovoLog Mix 50/50 FlexPen Prefilled syringe prevents the insulin cartridge from being completely emptied.

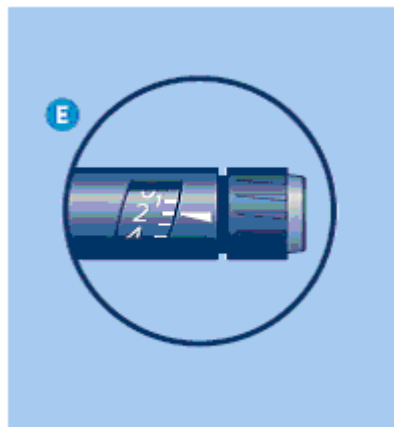

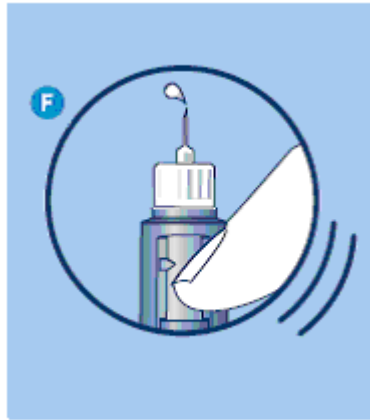

- Keep the needle pointing up and press the push button (on the end of the NovoLog Mix 50/50 FlexPen Prefilled syringe) all the way in (see diagram G below). You should see a drop of insulin at the needle tip. If you don't see a drop of insulin, repeat the procedure (dial 2 units, tap the insulin cartridge and press the push button) until insulin appears. You may need to do this up to 6 times. If you don't see a drop of insulin after 6 times, do not use the NovoLog Mix 50/50 FlexPen Prefilled syringe and contact Novo Nordisk at 1-800-727-6500.

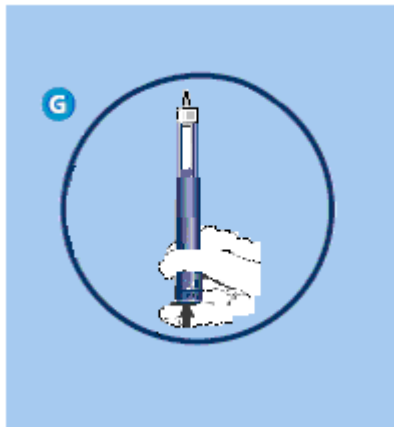

## 2. SETTING THE DOSE

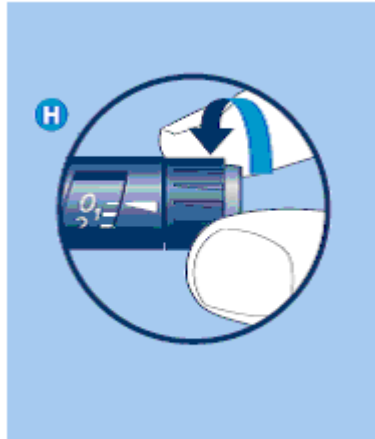

- Check and make sure that the dose selector is set at zero (0) (see diagram H above).
- Dial the number of units you need to inject by turning the dose selector so the arrow lines up with your dose.
- The dose can be corrected by turning the dose selector in either direction. When dialing back, be careful not to press the push button. Pressing the button will cause the insulin to come out. You cannot set a dose larger than the number of units left in the cartridge. You will hear a click for every single unit dialed. Do not set the dose by counting the number of clicks you hear.

## 3. GIVING THE INJECTION

Do the injection exactly as shown to you by your healthcare provider.

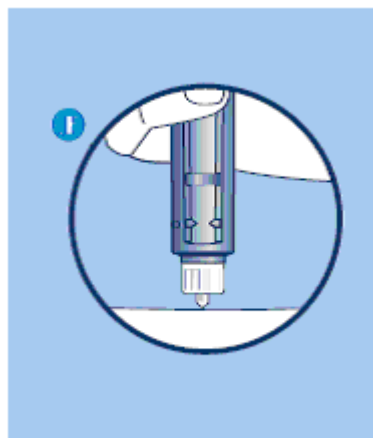

- Wipe the injection site with an alcohol swab and let the area dry.

- Pinch a fold of skin between 2 fingers, then push the needle into the pinched up skin (see diagram I above).
- Give the dose by pressing the push button all the way in (see diagram J below). Be careful to only press the push button when injecting.



- Keep the needle in the skin for at least 6 seconds, and keep the push button pressed all the way in until the needle has been pulled out from the skin. This will make sure that the full dose has been given. If blood appears after you take the needle out of your skin, press the injection site lightly with a finger. **Do not rub the area.**

#### After the injection

- Put your used NovoLog Mix 50/50 FlexPen Prefilled syringe and needles in a FDA-cleared sharps disposal container right away after use. Do not throw away (dispose of) loose needles and Pens in your household trash.
- If you do not have a FDA-cleared sharps disposal container, you may use a household container that is:
  - made of a heavy-duty plastic
  - can be closed with a tight-fitting, puncture-resistant lid, without sharps being able to come out
  - upright and stable during use
  - leak-resistant
  - properly labeled to warn of hazardous waste inside the container
- When your sharps disposal container is almost full, you will need to follow your community guidelines for the right way to dispose of your sharps disposal container. There may be state or local laws about how you should throw away used needles and syringes. For more information about the safe sharps disposal, and for specific information about sharps disposal in the state that you live in, go to the FDA's website at: <http://www.fda.gov/safesharpsdisposal>.

Do not dispose of your used sharps disposal container in your household trash unless your community guidelines permit this. Do not recycle your used sharps disposal container.

- Put the pen cap back on the NovoLog Mix 50/50 FlexPen Prefilled syringe.

**Healthcare providers, relatives, and other caregivers should follow general precautions for removing and disposing of needles to lessen the possible chance of needle stick injury.**

#### **4. FUTURE INJECTIONS**

**It is important that you use a new needle for each injection. Do not reuse or share your needles with other people.** You may give other people a serious infection, or get a serious infection from them. Follow the directions in steps 1, 2, and 3 above.

Before you inject, there must be at least 12 units of insulin left in the cartridge to make sure the remaining insulin is evenly mixed. If there are less than 12 units left, use a new NovoLog Mix 50/50 FlexPen Prefilled syringe.

The numbers on the insulin cartridge can be used to estimate the amount of insulin left in the NovoLog Mix 50/50 FlexPen Prefilled syringe. Do not use these numbers to measure the insulin dose. You cannot set a dose more than the number of units remaining in the cartridge.

#### **Mix (resuspend) the insulin before each injection:**

- Turn the NovoLog Mix 50/50 FlexPen Prefilled syringe up and down between position **1** and **2** so that the glass ball moves from one end of the insulin cartridge to the other (see diagram B above). Do this at least 10 times. Repeat the procedure until all of the insulin looks white and cloudy.
- Continue to follow the directions as described in steps 1, 2, and 3 above. If there is a delay in any step, the insulin will need to be mixed (resuspended) again.

## 5. FUNCTION CHECK

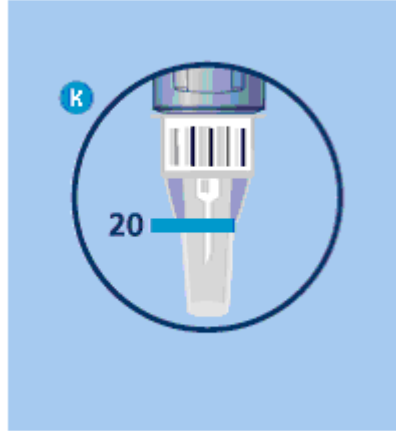

If your NovoLog Mix 50/50 FlexPen Prefilled syringe is not working the right way, follow this procedure:

- Screw on a new NovoFine needle.
- Do an airshot as described in step 1.
- Put the big outer needle cap onto the needle. Do not put on the inner needle cap.
- Turn the dose selector so that the arrow lines up with the 20 units in the dose indicator window.
- Hold the NovoLog Mix 50/50 FlexPen Prefilled syringe so the needle is pointing down.
- Press the push button all the way in.

The insulin should fill the lower part of the big outer needle cap (see diagram K above). If the NovoLog Mix 50/50 FlexPen Prefilled syringe has released too much or too little insulin, do the function check again. If it happens again, do not use your NovoLog Mix 50/50 FlexPen Prefilled syringe and contact Novo Nordisk at 1-800-727-6500.

## 6. IMPORTANT NOTES

- If you need to do more than 6 airshots before the first use of each NovoLog Mix 50/50 FlexPen Prefilled syringe to get a drop of insulin at the needle tip, do not use the NovoLog Mix 50/50 FlexPen Prefilled syringe. Contact Novo Nordisk at 1-800-727-6500.
- Remember to perform an airshot before each injection. See diagrams E and F.
- Do not drop the NovoLog Mix 50/50 FlexPen Prefilled syringe.
- Keep the NovoLog Mix 50/50 FlexPen Prefilled syringe with you. Do not leave it in a car or other place where it can get too hot or too cold.
- NovoLog Mix 50/50 FlexPen Prefilled syringe should be used with NovoFine disposable needles.

- **Do not** share your NovoLog Mix 50/50 FlexPen Prefilled syringe or needles with other people. You may give other people a serious infection, or get a serious infection from them.
- Do not put a disposable needle on the NovoLog Mix 50/50 FlexPen® Prefilled syringe until you are ready to use it. Remove the needle right after use. Do not recap the needle.
- Throw away the used NovoLog Mix 50/50 FlexPen Prefilled syringe without the needle attached.
- Always carry an extra NovoLog Mix 50/50 FlexPen Prefilled syringe with you in case the NovoLog Mix 50/50 FlexPen Prefilled syringe is damaged or lost.
- Keep your NovoLog Mix 50/50 FlexPen Prefilled syringe out of the reach of children. Use NovoLog Mix 50/50 FlexPen Prefilled syringe as directed to treat your diabetes. Do not share it with other people even if he or she also has diabetes.

## Instructions for Use NovoLog® Mix 50/50 PenFill® cartridge

**Do not share your NovoLog Mix 50/50 PenFill cartridge or PenFill cartridge compatible insulin delivery device with other people, even if the needle has been changed. You may give other people a serious infection, or get a serious infection from them.**

### Before using the NovoLog Mix 50/50 PenFill cartridge

1. Talk with your healthcare provider to find out where to inject NovoLog Mix 50/50 (injection sites) and how to give an injection with your insulin delivery device.
2. Read the instruction manual that comes with your insulin delivery device for complete instructions on how to use the PenFill cartridge with the device.
3. People who are blind or have vision problems should not use this PenFill cartridge without help from a person trained to use the PenFill cartridge with the device.

### How to use the NovoLog Mix 50/50 PenFill cartridge

1. **Check your insulin.** Just before using your NovoLog Mix 50/50 PenFill cartridge, check to make sure that you have the right type of insulin. This is especially important if you use different types of insulin.
2. **Carefully look at the PenFill cartridge and the insulin inside it.** The insulin should be white and cloudy (after being mixed). The tamper-resistant foil should be in place before the first use. If the foil has been broken or removed before your first use of the PenFill cartridge, or if the insulin is clear, do not use it. Call Novo Nordisk at 1-800-727-6500.
3. **Gather your supplies** for injecting NovoLog Mix 50/50. You will need your NovoLog Mix 50/50 PenFill cartridge, your insulin delivery device, NovoFine® single use needles and an alcohol swab. Be sure to use an insulin delivery device that is made to work with NovoLog Mix 50/50 PenFill cartridges. These insulin delivery devices can be used with a NovoPen® 3 PenMate® if you would like to hide the needle from view during injection.
4. **Wash your hands** well with soap and water.
5. **Clean your injection site** with an alcohol swab and let the injection site dry before you inject.
6. Before inserting a 3 mL PenFill cartridge into your insulin delivery device for the first time, roll the PenFill cartridge between your palms 10 times. These steps should be done with the 3 mL PenFill cartridge in a horizontal (flat) position (see Diagram 1 below). Then turn the PenFill cartridge up and down

between positions **a** and **b** (see Diagram 2 below) so the glass ball moves from one end of the PenFill cartridge to the other. Do this at least 10 times. Repeat the rolling and turning steps until the insulin looks white and cloudy. Mixing is easier when the insulin is at room temperature.

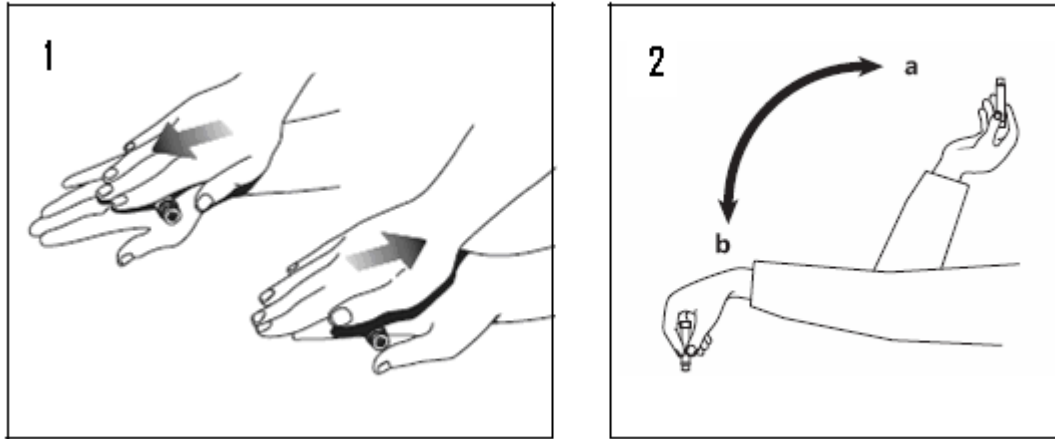

7. Insert the PenFill cartridge into the insulin delivery device. Wipe the front rubber stopper of the 3 mL PenFill cartridge with an alcohol swab, then screw on a new needle (see Diagram 3 below).

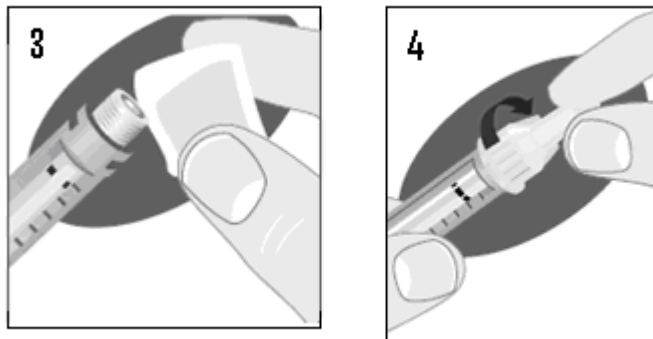

For NovoFine needles, remove the big outer needle cap and the inner needle cap (see Diagram 4 above). Always use a new needle for each injection to prevent infection. **Do not** share your PenFill cartridge or PenFill cartridge compatible insulin delivery device with other people, even if the needle has been changed. You may give other people a serious infection, or get a serious infection from them.

**Giving the airshot before each injection:**

To prevent the injection of air and make sure insulin is delivered; you must do an air shot before each injection. Hold the device with the needle pointing up and gently tap the PenFill cartridge holder with your finger a few times to raise any air bubbles to the top of the PenFill cartridge (see Diagram 5 below). Do the airshot as described in the device instruction manual.

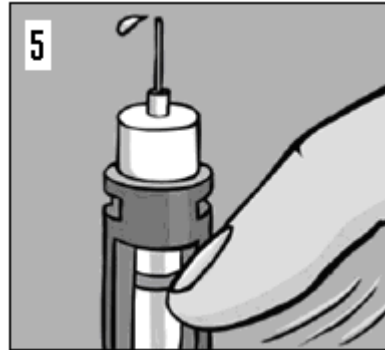

### Giving the injection

8. Dial the number of units you need to inject on the device (see Diagram 6 below). Inject right away as you were shown by your healthcare provider. If there is a delay between mixing of the insulin and the injection, the insulin will need to be mixed again.

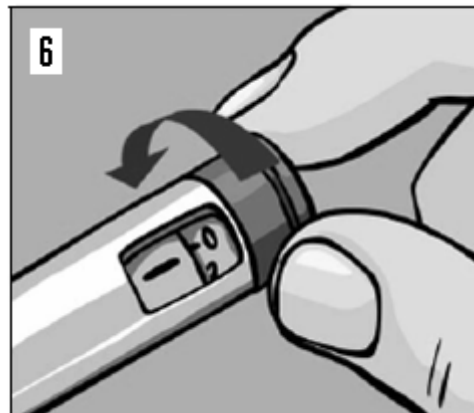

9. Pinch a fold of skin between 2 fingers, then push the needle into the pinched up skin (see Diagram 7 below). Inject the dose by pressing the push button all the way in. Keep the needle in the skin for at least 6 seconds, and keep the push button pressed all the way in until the needle has been pulled out from the skin. This will make sure that the full dose has been given. If blood appears after you take the needle out of your skin, press the injection site lightly with a finger. **Do not rub the area.**

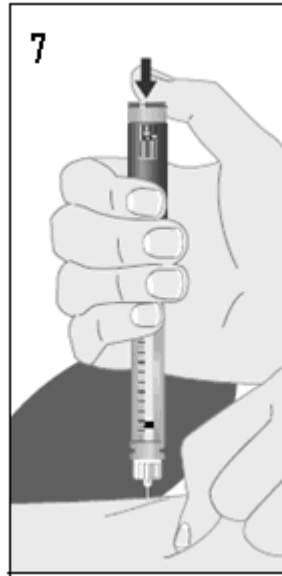

### After the injection

10. Remove the needle from the insulin delivery device after each injection. Keep the 3 mL PenFill cartridge in the insulin delivery device. The needle should not be attached to the insulin delivery device during storage. This will prevent infection or leakage of insulin, and will help ensure that you receive the right dose of NovoLog Mix 50/50.
- Put your used NovoLog Mix 50/50 PenFill cartridge and needles in a FDA-cleared sharps disposal container right away after use. Do not throw away (dispose of) loose needles and Pens in your household trash.
  - If you do not have a FDA-cleared sharps disposal container, you may use a household container that is:
    - made of a heavy-duty plastic
    - can be closed with a tight-fitting, puncture-resistant lid, without sharps being able to come out
    - upright and stable during use
    - leak-resistant
    - properly labeled to warn of hazardous waste inside the container
  - When your sharps disposal container is almost full, you will need to follow your community guidelines for the right way to dispose of your sharps disposal container. There may be state or local laws about how you should throw away used needles and syringes. For more information about the safe sharps disposal, and for specific information about sharps disposal in the state that you live in, go to the FDA's website at:

<http://www.fda.gov/safesharpsdisposal>.

Do not dispose of your used sharps disposal container in your household trash unless your community guidelines permit this. Do not recycle your used sharps disposal container.

11. Put the pen cap back on the insulin delivery device.

### **After the first use of the 3 mL PenFill cartridge**

1. If the 3 mL PenFill cartridge is already in the insulin delivery device, turn it upside down between positions **a** and **b** (see Diagram 2 above), so that the glass ball moves from one end of the 3 mL PenFill cartridge to the other. Do this until all of the insulin looks white and cloudy.
2. Before you inject, there must be at least 12 units of insulin left in the PenFill cartridge to make sure the remaining insulin is evenly mixed. If there are less than 12 units left, use a new 3 mL PenFill cartridge.
3. An airshot should be done before each injection. Do the airshot as described in the device instruction manual.
4. Do not remove the 3 mL PenFill cartridge from the insulin delivery device.
5. Put the pen cap back on the insulin delivery device.

### **IMPORTANT NOTES**

- Do not use if you need to do more than 6 airshots before the first use of each NovoLog Mix 50/50 PenFill cartridge to get a drop of insulin at the needle tip. Contact Novo Nordisk at 1-800-727-6500.
- Remember to do an airshot before each injection. See the device instruction manual.
- Do not drop the NovoLog Mix 50/50 PenFill cartridge and insulin delivery device.
- Keep the NovoLog Mix 50/50 PenFill cartridge and insulin delivery device with you. Do not leave it in a car or other places where it can get too hot or too cold.
- NovoLog Mix 50/50 PenFill cartridges are designed for use with NovoFine disposable needles.
- **Do not** share your NovoLog Mix 50/50 PenFill cartridges or needles with other people. You may give other people a serious infection, or get a serious infection from them.

- Do not put a disposable needle on the NovoLog Mix 50/50 PenFill cartridge and insulin delivery device until you are ready to use it. Remove the needle right after use. Do not recap the needle.
- Throw away the used NovoLog Mix 50/50 PenFill cartridges without the needle attached.
- Always carry an extra NovoLog Mix 50/50 PenFill cartridge with you in case the NovoLog Mix 50/50 PenFill cartridge is damaged or lost. Always keep the NovoLog Mix 50/50 PenFill cartridge in the outer carton when you are not using it in order to protect it from light.
- Keep your NovoLog Mix 50/50 PenFill cartridge out of the reach of children. Use NovoLog Mix 50/50 PenFill cartridges as directed to treat your diabetes. Do not share it with other people even if he or she also has diabetes.